

TRANSFORMADOR

DISTRIBUCION



Transformador DISTRIBUCION

La experiencia de más de 35 años en el mercado, hacen que Nuestros transformadores de distribución se caractericen por su incorporada calidad y confiabilidad.

La línea de transformadores de distribución está diseñada con especificaciones internas exigentes y excede lo solicitado por la Norma IRAM 2250 con tensiones de hasta 35 kV.

Los equipos se fabrican con o sin tanque de expansión, con conmutadores sin tensión, con todos los accesorios que requiere la Norma solicitada de aplicación, o especiales de acuerdo a los requerimientos de los Clientes.

Nuestra línea incluye, los transformadores tipo Zigzag, con neutro accesible para la puesta a tierra del sistema, la potencia dimensionada de acuerdo a la corriente de falla a tierra y el tiempo especificado de modo de que actúen las protecciones del alimentador.

Asimismo, nos especializamos en reactores en serie que limitan la corriente de falla a tierra a valores preestablecidos de corriente y duración de falla.

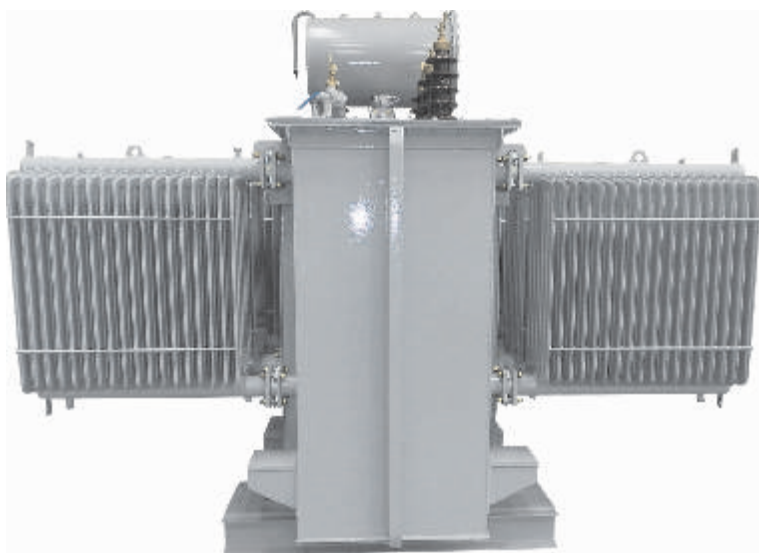

Transformador DISTRIBUCION

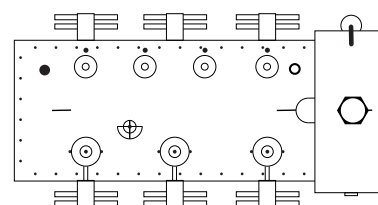
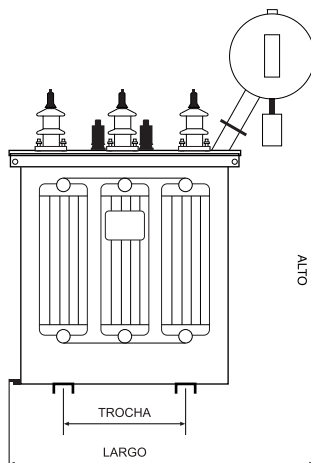
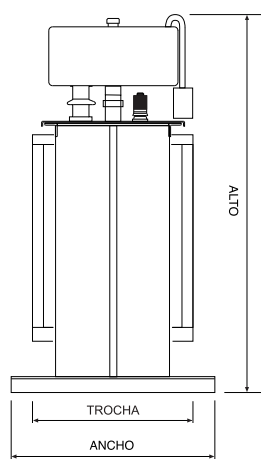
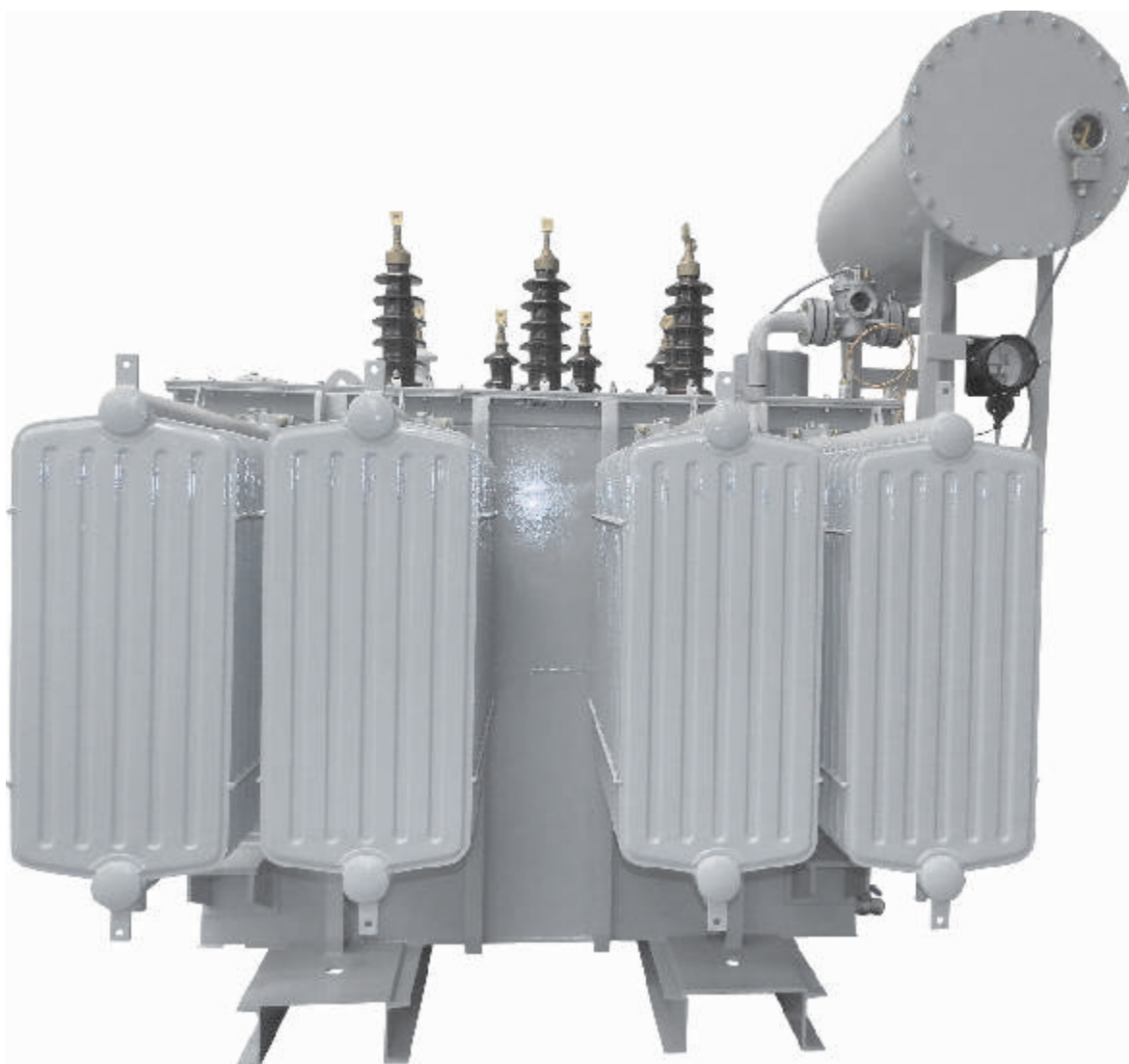

Transformador DISTRIBUCION

















Normas IRAM 2250

Transformadores de Distribución Relación 13.200 ± 2 x 2,5%/400-231 V/V								
Potencia (kVA)	Pérdidas (W)		Ucc (%)	Dimensiones (mm)				Masa (kg)
	P ₀	P _{cc}		Largo	Ancho	Alto	Trocha	
25	160	600	4,00	1250	750	1250	600	410
40	200	900	4,00	1300	750	1300	600	490
63	270	1350	4,00	1300	750	1300	600	540
80	315	1500	4,00	1450	750	1300	600	620
100	350	1750	4,00	1450	750	1350	600	660
125	420	2100	4,00	1500	750	1350	600	700
160	500	2500	4,00	1600	750	1450	600	840
200	600	3000	4,00	1650	850	1450	600	890
250	700	3500	4,00	1650	900	1450	700	1040
315	850	4250	4,00	1650	900	1500	700	1220
400	1000	5000	4,00	1700	950	1700	700	1490
500	1200	6000	4,00	1700	1050	1700	700	1760
630	1450	7250	4,00	1700	1050	1900	800	1960
800	1750	8750	5,00	1950	1050	2025	800	2390
1000	2000	10500	5,00	2100	1100	2050	800	3080
1250	2300	13800	5,00	2200	1250	2150	1000	3540
1600	2700	17000	6,00	2400	2200	2100	1000	4130
2000	3000	21500	6,00	2500	2550	2200	1000	5060
2500	3300	24800	6,00	2700	2500	2300	1200	6110
3000	3750	27000	6,00	2800	2600	2700	1200	6900

Transformadores de Distribución Relación 33.000 ± 2 x 2,5%/400-231 V/V								
Potencia (kVA)	Pérdidas (W)		Ucc (%)	Dimensiones (mm)				Masa (kg)
	P ₀	P _{cc}		Largo	Ancho	Alto	Trocha	
16	130	480	4,00	1550	800	1650	600	500
25	190	650	4,00	1550	750	1650	600	560
40	290	900	4,00	1750	800	1650	600	710
63	320	1500	4,00	1750	800	1650	600	730
80	330	1600	4,00	1750	800	1850	600	780
100	420	1900	4,00	1750	850	1850	600	930
125	500	2500	4,00	1850	850	1850	600	1050
160	600	2800	4,00	1850	900	1900	600	1150
200	700	3250	4,00	1850	900	1900	600	1280
250	850	4000	4,00	1850	1000	1950	700	1470
315	950	4800	4,00	1850	1050	1950	700	1550
400	1200	5000	4,00	1950	1050	2200	700	2060
500	1250	6400	4,00	1950	1050	2300	700	2350
630	1500	7600	4,00	2150	1150	2300	800	2650
800	1800	9800	5,00	2200	1200	2300	800	3150
1000	2200	11700	5,00	2300	1200	2450	800	3650
1250	2500	14200	5,00	2350	1300	2500	1000	4300
1600	2900	17800	6,00	2600	2400	2500	1000	5000
2000	3200	22000	6,00	2700	2600	2600	1000	5400
2500	3600	26000	6,00	3000	2800	2750	1200	6000



 Trabajos realizados

- | | | | |
|--|--|---|---|
|  ARGENTINA |  CAMERUN |  EL SALVADOR |  PERU |
|  ARABIA SAUDITA |  CHILE |  FRANCIA |  PUERTO RICO |
|  BOLIVIA |  CHINA |  MEXICO |  URUGUAY |
|  BRASIL |  DOMINICANA |  PARAGUAY |  VENEZUELA |

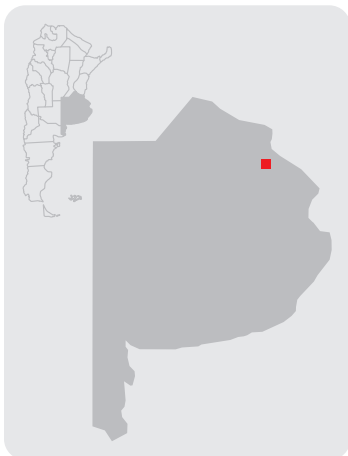

El Partenón 1299 :: 9 de Abril (B1839DIM) :: Esteban Echeverría :: Buenos Aires :: Argentina

Tel.: (+54 11) **4693-2220**
Fax: (+54-11) **4693-2525**

info@losconce.com.ar
www.losconce.com.ar